

COLLECT, MONITOR, AND MANAGE YOUR SOLAR SYSTEM PRODUCTION WITH THE TIGO SMART PLATFORM

The Tigo Access Point (TAP) improves the data management of your solar array by wirelessly communicating with Tigo smart modules and retrofit devices. TAP also greatly improves safety with module-level deactivation.

When paired with a Cloud Connect Advanced (CCA), the TAP provides unparalleled visibility into your solar installation.

VISIBILITY

Communicate directly with TS4 units using the Tigo SMART app on a mobile device for the fastest commissioning.

SAFETY

Provide grid status to TS4 MLPE for rapid shutdown UL compliance.

EASE OF INSTALLATION

Improved design flexibility and large inner compartment for quick wiring.



TIGO ACCESS POINT (TAP)

- Collect data from up to 300 TS4 units
- Wireless mesh communication
- High definition sampling rate
- Scalable architecture
- Mounts easily on module frame without tools

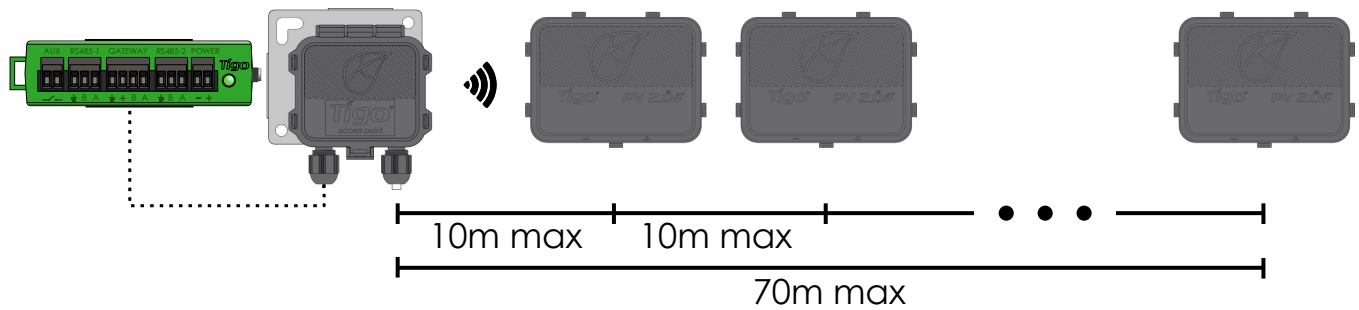
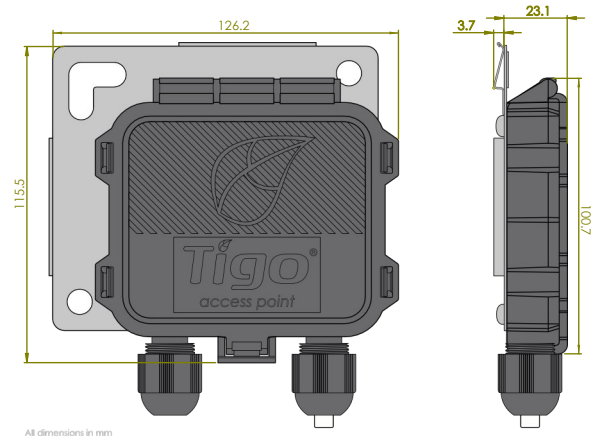

Electrical Specifications

Input voltage range: 5V_{DC} - 25V_{DC}

Consumption: 0.5W average, 1W peak

Recommended cable type: RS485, 18-22AWG

Mechanical Specifications

Dimensions: 126.2mm x 130.0mm x 26.8mm (with bracket)

Weight: 227g (0.5lbs)

Operating temperature range: -30°C to +70°C (-22°F to +158°F)

Environmental rating: IP68, Type 4R

Range and Capacity

Maximum distance from TAP to closest TS4: 10m (33ft)

Maximum distance from TAP to farthest TS4: 70m (230ft)

Each TAP supports up to 300 TS4 units

For more information on Tigo products:

www.tigoenergy.com/products

For sales and ordering information:

sales@tigoenergy.com or 1.408.402.0802

For technical information:

<http://support.tigoenergy.com>

For additional info and product selection assistance, use Tigo's online design tool at www.tigoenergy.com/design

